

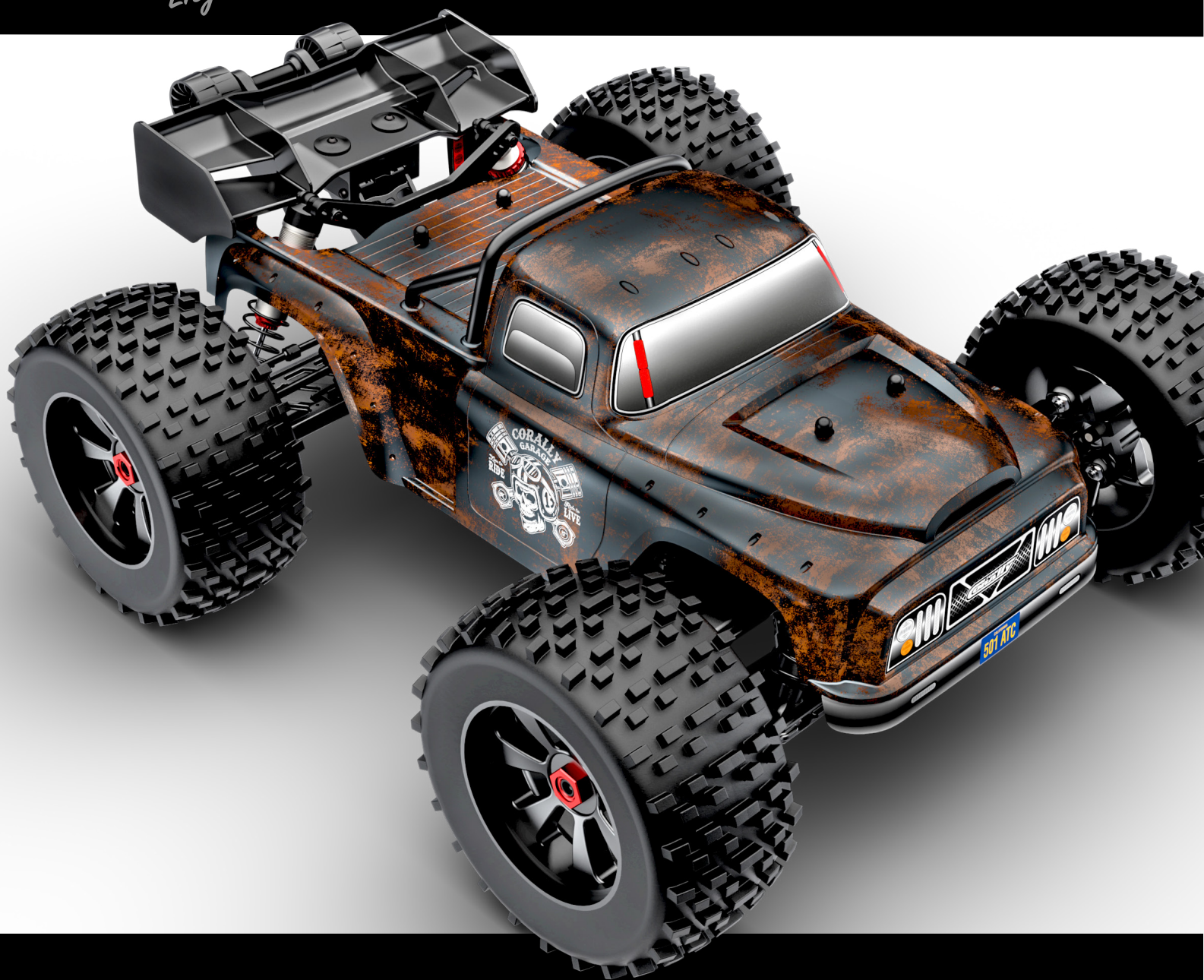

*Engineered to be the fastest*

# QUICK START USER GUIDE



**C-00165 DEMENTOR  
1/8TH SCALE 4WD  
ELECTRIC READY TO RUN**

[www.corally.com](http://www.corally.com)

## INTRODUCTION

Thank you for purchasing a Team Corally car. This manual describes the instructions for using the model and the electronic components. You will also find some tips on how to maintain your RC model so that you can enjoy it for years to come. You have purchased one of the most efficient models available on the market that has been designed by a team of professionals. You will also benefit from the best after-sales support. All Team Corally models guarantee a high quality of manufacture and performance that guarantees you a high satisfaction of use and services provided by the Team Corally. Always take the time to read the instructions carefully in order to follow all the procedures to use your RC model safely for you and for other people and property in the area. This will allow you to take full advantage of all the performance of your RC model.

Please also check the website [www.corally.com/Downloads/](http://www.corally.com/Downloads/) to check if you have the latest version of this instruction manual. (Version: see bottom cover of this manual)

If you have any questions about the model and its components, you can send a message to [info@corally.com](mailto:info@corally.com)

We also recommend that you get help from an experienced model maker or your dealer.

You will find all the references of the spare parts on the website [www.corally.com](http://www.corally.com)

## TERM OF USE

The user is responsible for the use of your model. The user assumes all risks associated with the use of the model. This model is not intended for use by children under 14 years of age without the supervision of a responsible adult who is familiar with the dangers of using a RC model. Team Corally / JSP Group Intl bvba, its manufacturers, distributors and resellers cannot control the use and load of the model and therefore cannot be held responsible for any damage to property and damage caused to persons resulting from the use of this product. You must accept these conditions and consider yourself fully responsible for the use of this product. If not, do not use this product.

Due to the continuous development of our products, the exact specifications of the kit may vary. If you have a problem with your new kit, please contact the store where you purchased it, indicating the part number(s).

Team Corally / JSP Group Intl bvba reserves the right to change any specification without notice. All rights reserved.

## READ FIRST

This owner's manual is designed for use with your vehicle and contains the instructions you will need to operate and maintain your vehicle.

- We know you want to start driving immediately after unpacking, but it is very important that you take the time to read this manual carefully, even if you are an experienced R/C driver.
- Read carefully and follow all instructions in this manual. Failure to comply with the instructions will be considered as abuse and/or negligence which may result in the cancellation of the warranty.
- Your vehicle is designed to operate on uneven terrain. However, dust, sand, water and carpet fibres can get into your car's workspaces and can damage your vehicle if they are not removed quickly. We do not guarantee any warranty on your vehicle against damage caused by external elements such as sand, dirt or water. Users are responsible for the maintenance and safe operation of this vehicle.
- This product is not a toy. It is not suitable for users under 14 years of age, unless they are supervised by adults.
- Never attempt to disassemble electronic components. These have been carefully calibrated at the factory.
- Only improve your car with parts made for your car. If you upgrade performance, replace the entire system (such as the motor, inverter, battery, etc.) so that all components are properly adapted. Any malfunction resulting from a custom modification will void your warranty.
- Before driving your vehicle, please read this manual in its entirety and examine your vehicle and radio control system for any defects.
- For better performance, some adjustments may be necessary.
- This vehicle requires a battery (included in the car or in the packaging). Make sure the vehicle's battery is sufficiently charged before driving, otherwise you may lose control of the vehicle.
- The radio transmitter requires 4 AA batteries (not included)
- Always remove or disconnect the battery from the vehicle to the inverter when not in use.
- Please drive your car in a spacious place. Never drive your car on the street or in traffic. Public places are subject to specific legislation by country, city, municipality, please comply with the legislation for the use of RC models in your region.
- This product is fully assembled in the factory. We accept no liability for damage and/or accidents resulting from custom modifications and/or malfunctions.

## USE PRECAUTIONS

Failure to operate your model in a safe and responsible manner may result in injury to yourself, others or damage to property around you.

- Do not use your model on public roads or in areas where you may encounter pedestrians or riders.
- Do not operate in a congested area or in crowds.
- Do not operate in areas where loud noises can disturb others, such as hospitals and residential areas.
- Do not operate your model with obstructed line of sight, at night or near water.
- Your model is radio controlled, it is subject to possible radio interference. Radio interference can cause loss of control of your model. Be careful.
- Take care not to injure yourself while using tools to adjust or upgrade your model.
- Since the model contains small parts, keep out of reach of children while assembling and/or disassembling your model.
- If your model becomes stuck against an object, release the throttle and retrieve it by hand
- Do not continue to apply the throttle when your model is stuck. This may damage the motor and/or ESC/Receiver unit.
- Turn OFF your model and don't use it if it runs erratically. Please do not use your model again until the problem has been solved.
- Keep the wheels of the model off the ground when checking the operation of the radio equipment.
- When learning to operate your model, go to an area that has no obstacles that can damage your model.
- Before and after each use, check all the screws on the model.
- To maintain the best performance, check that all moving parts move freely.

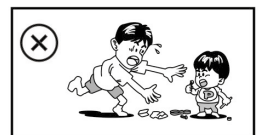
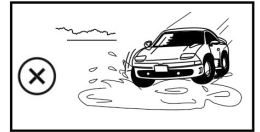
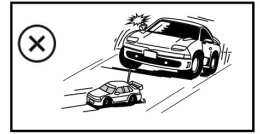

**Take all necessary precautions before, during and after using your model. You are responsible for the safe assembly, maintenance and use of your model.**

**In case of any questions, contact your local reseller or contact Team Corally support for assistance.**

## SAFETY PRECAUTIONS

For your safety, always use wear gloves and goggles when assembling and maintaining your model.

Always take all necessary precautions when handling products (silicone oil, grease, thread lock, cyanolyte glue, fuel) for the operation of the model. (Refer to the manufacturer's instructions)

For your safety, to keep the warranty and obtain the best performance, always use original CORALLY genuine parts.

Contains: LEAD (CAS 7439-92-1) ANTIMONY (CAS 7440-36-0)

**WARNING:** This product contains a chemical known to the state of California to cause cancer and birth defects or other reproductive harm.

**CAUTION: CANCER HAZARD**

Contains lead, a listed carcinogen. Lead is harmful if ingested. Wash thoroughly after using.

**DO NOT** use product while eating, drinking or smoking.

If material defects or manufacturing faults should arise in a product distributed or manufactured by Team Corally / JSP Group Intl bvba, and purchased by a consumer, we Team Corally / JSP Group Intl bvba acknowledge the obligation to correct those faults or defects within the limitations described below. This manufacturer's warranty is in addition to, and does not affect, the legal or contractual rights of the consumer which arise from the purchase of such products. Team Corally / JSP Group Intl bvba guarantees the consumer that its products are free from material, manufacturing, and construction faults, as determined by the general state of knowledge and technology valid at the time of manufacturing. The fault responsible for causing the damage must be proven to have been present in the product at this time. Claims for compensation arising from consequential damage or product liability will not be considered valid unless they fall under peremptory provisions of the law. If material defects or manufacturing faults should arise in a product distributed or manufactured by Team Corally / JSP Group Intl bvba in the European community (EC) and purchased by a consumer, then Team Corally / JSP Group Intl bvba undertakes to correct those defects within the limitations described below. This manufacturer's declaration does not affect the consumer's legal or contractual rights regarding defects arising from the purchase contract between the consumer and the dealer or reseller. Extend of the Warranty

If a claim is made under warranty, we take at our discretion to repair or replace the defective goods. We will not consider supplementary claims, especially for reimbursement of costs relating to the defect (e.g. installation / removal costs) and compensation for consequent damages unless they are allowed by statute. This does not affect claims on legal regulations, especially according to the product liability law.

### **Provisions of the Warranty**

The purchaser is required to make the warranty claim in writing, and must enclose original proof of purchase (e.g. invoice, receipt, delivery note) and the appropriate warranty card. He must send the defective goods to our local representatives or directly to Team Corally / JSP Group Intl bvba, Geelseweg 80, 2250 Olen, Belgium at his own risk and cost.

The purchaser should state the material defect or manufacturing fault, or symptoms of the fault, as accurate as possible, so that we can check if our warranty obligation is applicable. The goods are transported from the consumer to us, and from us to the consumer, entirely at the risk and cost of the consumer.

### **Invalidation of the Warranty**

The consumer cannot make a claim under warranty when the fault is affecting the use of the product arising from natural wear, competition use, or improper use (including installation) or external forces. The consumer's adherence to the building and operating instructions relevant to the model, including the installation, operation, use of, and maintenance of, model-related components cannot be supervised by Team Corally / JSP Group Intl bvba. Therefore Team Corally / JSP Group Intl bvba is in no way liable for loss, damage, or costs resulting from improper use, or behaviour in any way connected to the above described provisions. Unless otherwise required by law, Team Corally / JSP Group Intl bvba is in no way whatever liable to provide compensation for damages arising from the improper use of the model (including personal injury, death, damage to buildings, loss of turnover, loss of business, or interruption of business, or any other direct, or indirectly caused, consequential damage).

### **Duration of Validity**

The claim period is 24 months from the date of purchase of the product by the consumer from a dealer in the European Community (EC) counted from the date of purchase. The claim period is 12 months from the date of purchase of the product by the consumer from a dealer outside the European Community (EC) counted from the date of purchase. If a defect arises after the end of the claim period, or if evidence or documents required according to this declaration in order to make the claim valid are not presented until after this period, then the consumer forfeits any rights or claims from this declaration. The guarantee period is not prolonged by the granting of any claims within the framework of this warranty, especially in the case of repair or replacement. The guarantee period also does not restart in such cases.

### **Warranty Expiration**

If we do not acknowledge the validity of a claim based on this declaration within the claim period, all claims based on this declaration will expire after six months from the time of registering the claim; however this cannot occur prior to the end of the claim period.

For any support, you can contact us by email at [info@corally.com](mailto:info@corally.com)



## LIPO BATTERY SAFETY PRECAUTIONS

- Follow and respect the manufacturer's instructions for use
- It is important to check that your ESC is set to LIPO if you are using a LIPO battery. Failure to comply with this instruction will result in increased battery discharge and may cause fire and damage to persons and property.
- When charging or storing LiPo batteries always use LiPo Safety Bag (Flame retardant).
- Always respect the maximum rate and voltage specified by the battery manufacturer.
- Charge the LIPO battery outdoors or in a ventilated area away from flammable objects and surfaces.
- NEVER leave your LiPo battery unattended while charging.
- If the battery swells during charging, stop charging immediately and disconnect the battery from the charger. Leave the battery outside for a few hours and observe. Then recycle the battery according to the instructions of your country/region. Never dispose of a LIPO battery with domestic waste.
- Before recycling your defective battery, it must be neutralized. Take a plastic container, fill it with water and add a lot of salt until the water becomes opaque. Place the LIPO battery in the water and leave for 24 hours. Check with a voltmeter that the voltage is 0.0V. Then recycle the battery according to local regulations.
- Never charge a damaged or inflated battery.
- Never discharge the battery cells below 3.2V.
- Always use the appropriate balancer/charger when charging your LiPo battery pack.
- When the battery is empty, check the temperature of the battery before charging it. If the battery is very hot, wait until it cools before charging it.
- Never charge a very hot battery as this may cause an explosion or fire.
- When the battery is empty, recharge it immediately. Do not store an empty battery, the battery will continue to discharge, it will fall below the minimum voltage and become unusable.

## KIT CONTENT (Depends on the selected model)

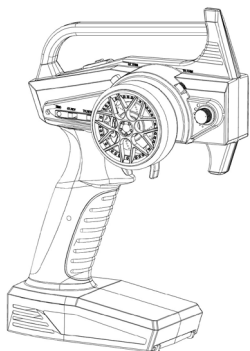

Transmitter

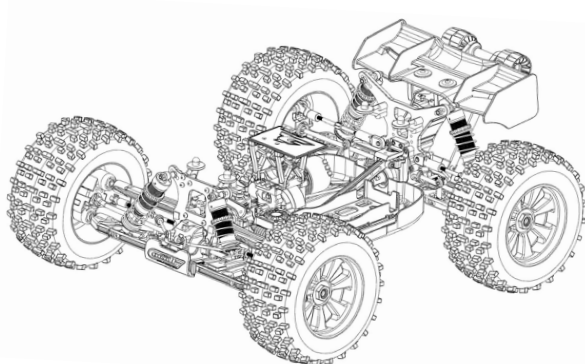

RTR Model (Chassis with Body)



[www.corally.com/Downloads/](http://www.corally.com/Downloads/)

User Guide

## REQUIRED FOR OPERATION (Not included)

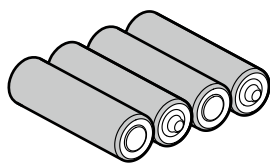

4x AA Batteries  
for the Transmitter

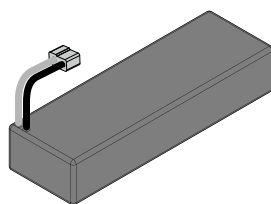

4S - 14.8V LiPo Battery

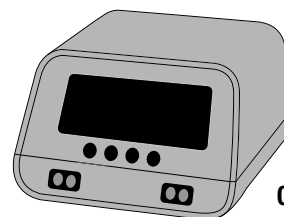

Charger

Hex Drivers

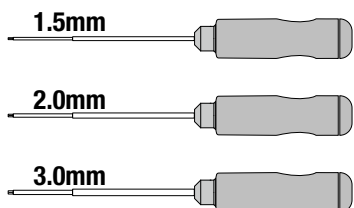

1.5mm

2.0mm

3.0mm

Cross Wrench

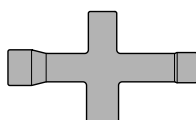

Silicone Oil  
(for maintenance)

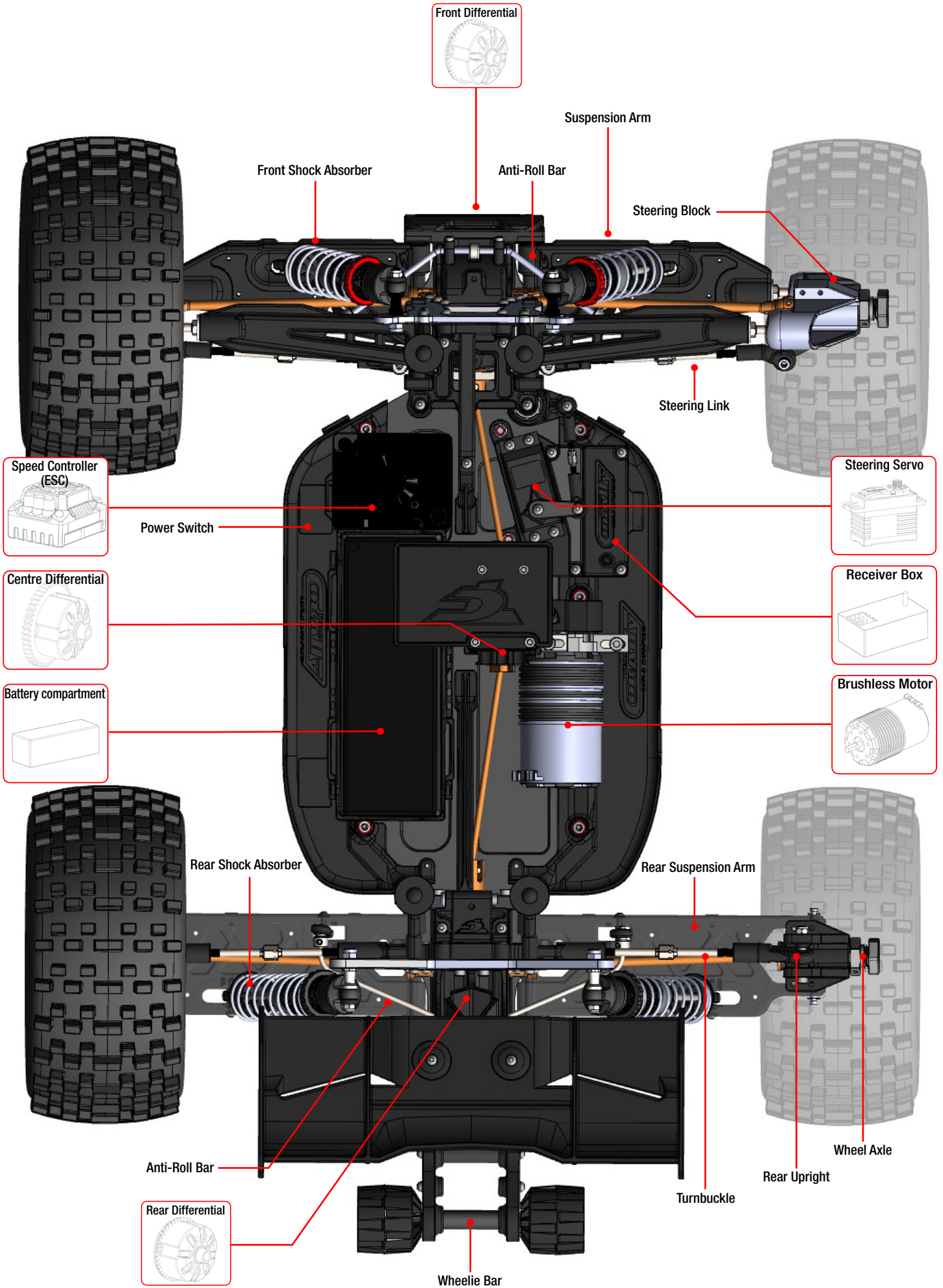

READ THE INSTRUCTIONS



CHARGE THE BATTERY

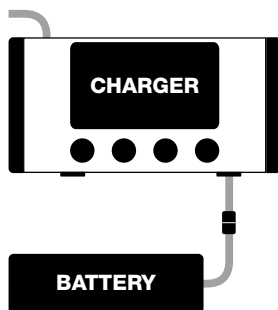

INSTALL 4x AA BATTERY

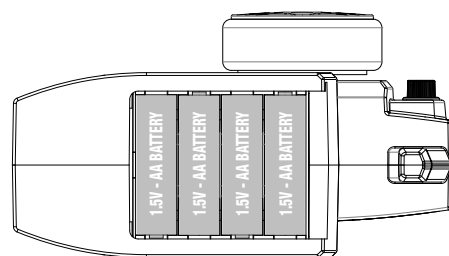

MAKE SURE THAT ALL SCREWS AND NUTS ARE TIGHTENED PROPERLY.

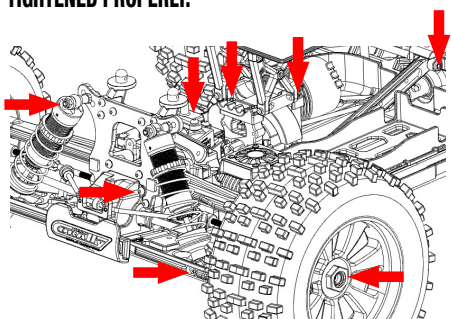

INSTALL THE BATTERY

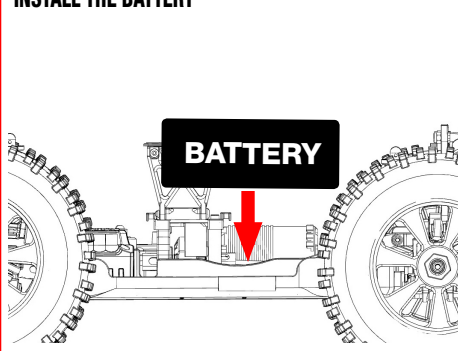

TURN ON THE TRANSMITTER (Always First)

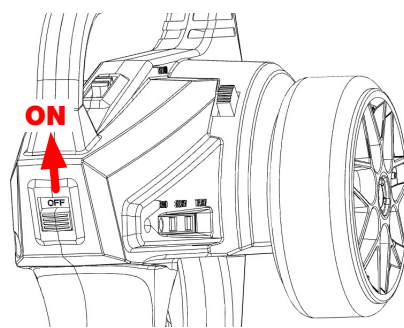

1. CONNECT THE BATTERY TO THE ESC  
2. SWITCH ON THE ESC

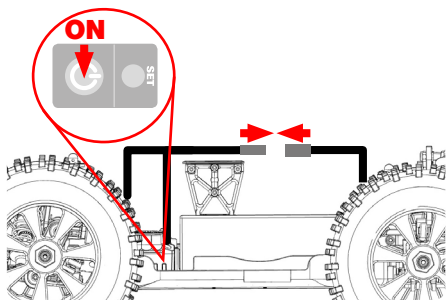

CHECK THE FUNCTIONS

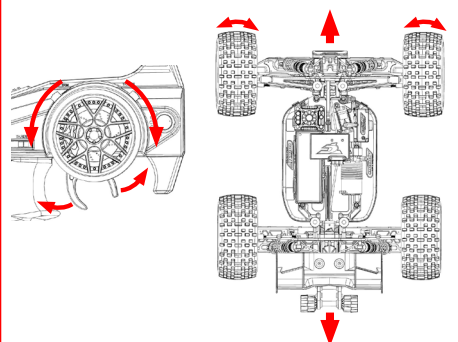

CHECK THE RADIO SYSTEM RANGE

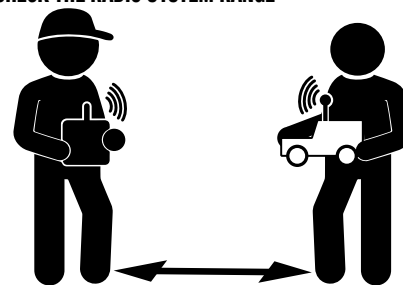

Move away from the max. distance you will drive the vehicle.  
Check that the vehicle responds properly to the controls.  
If not, reduce the distance or change the driving location.

DRIVE SLOWLY TO BEGIN

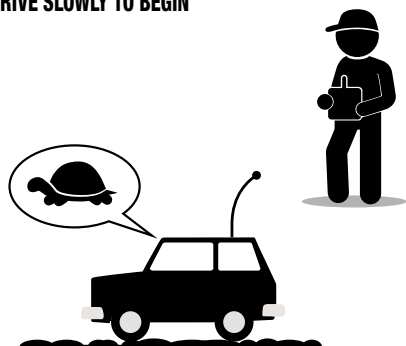

WHEN FINISHING

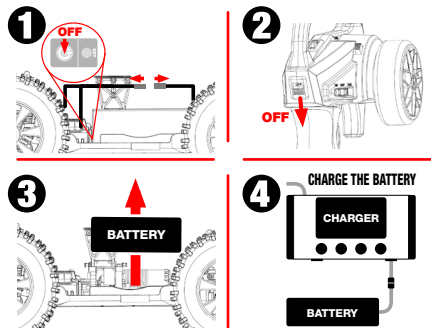

CLEAN AND MAINTAIN YOUR VEHICLE





**FRONT TOE**

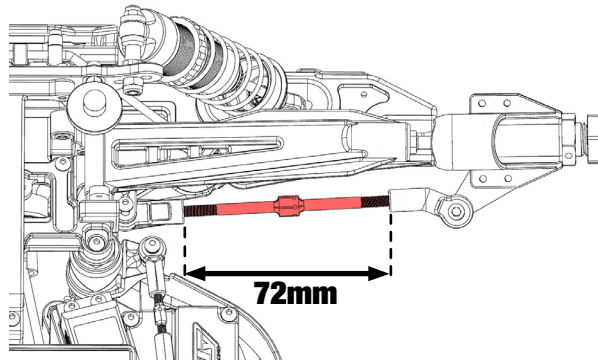
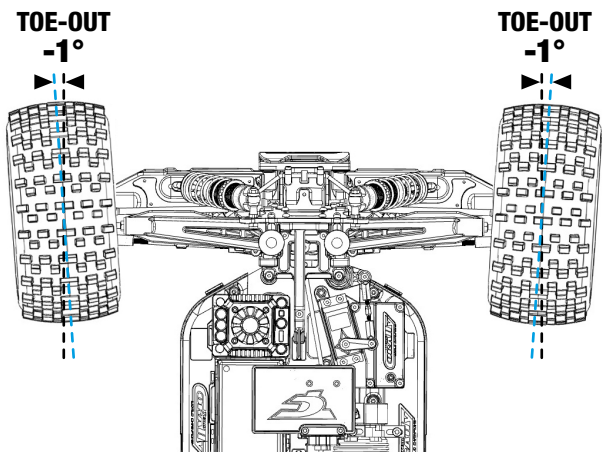

Adjust the angle by screwing the TURNBUCKLE.

**FRONT CAMBER**

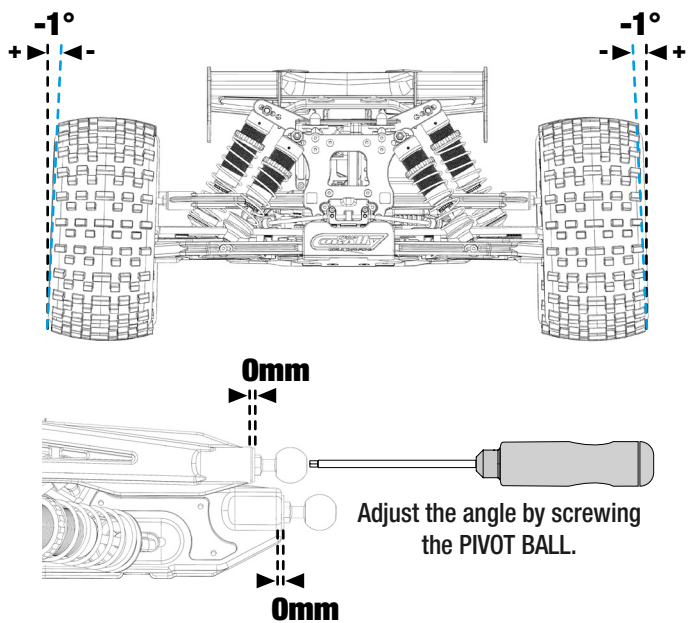

**REAR CAMBER**

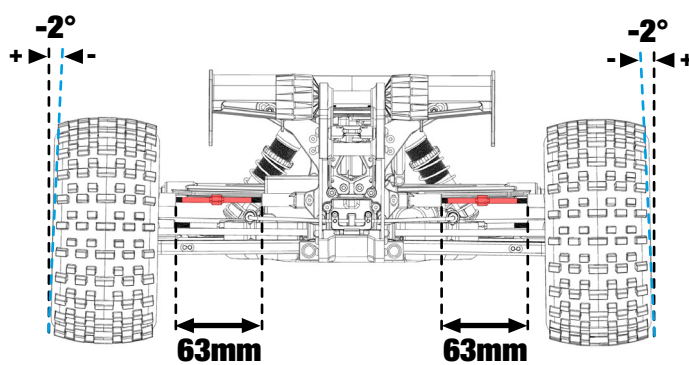

Adjust the angle by screwing the TURNBUCKLE.

**FRONT CASTER**

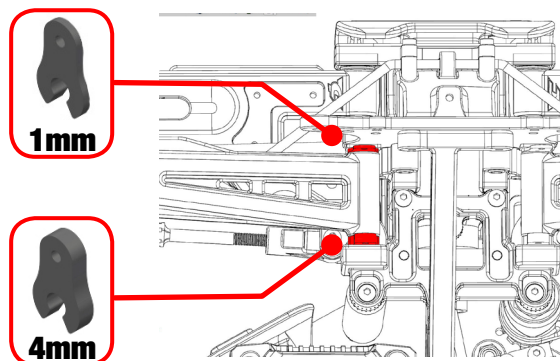
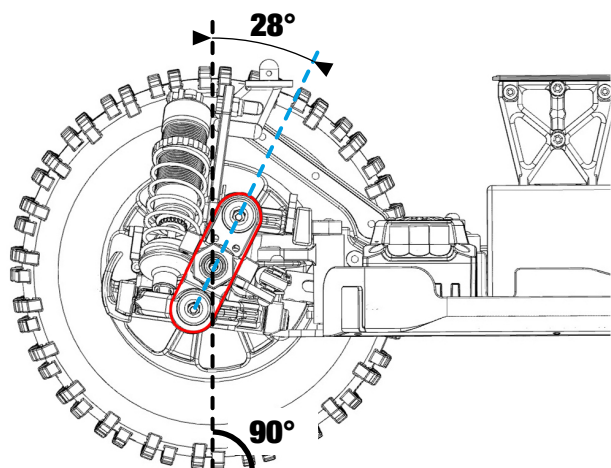

To change the Caster Angle, move the Upper Suspension Arm forward or backward using the different CASTER CLIPS sizes.



## SUSPENSION TRAVEL

It is important to properly adjust the travel of the suspension arm to prevent the shock absorber from reaching the end of its travel and damaging it.

- Place the chassis on a block in order to release the suspension to the maximum.
- Measure the distance between the 2 fixing points of the shock absorber.
- If necessary adjust the FR & RE suspension travel by screwing the set screw on the FR & RE lower suspension arm.

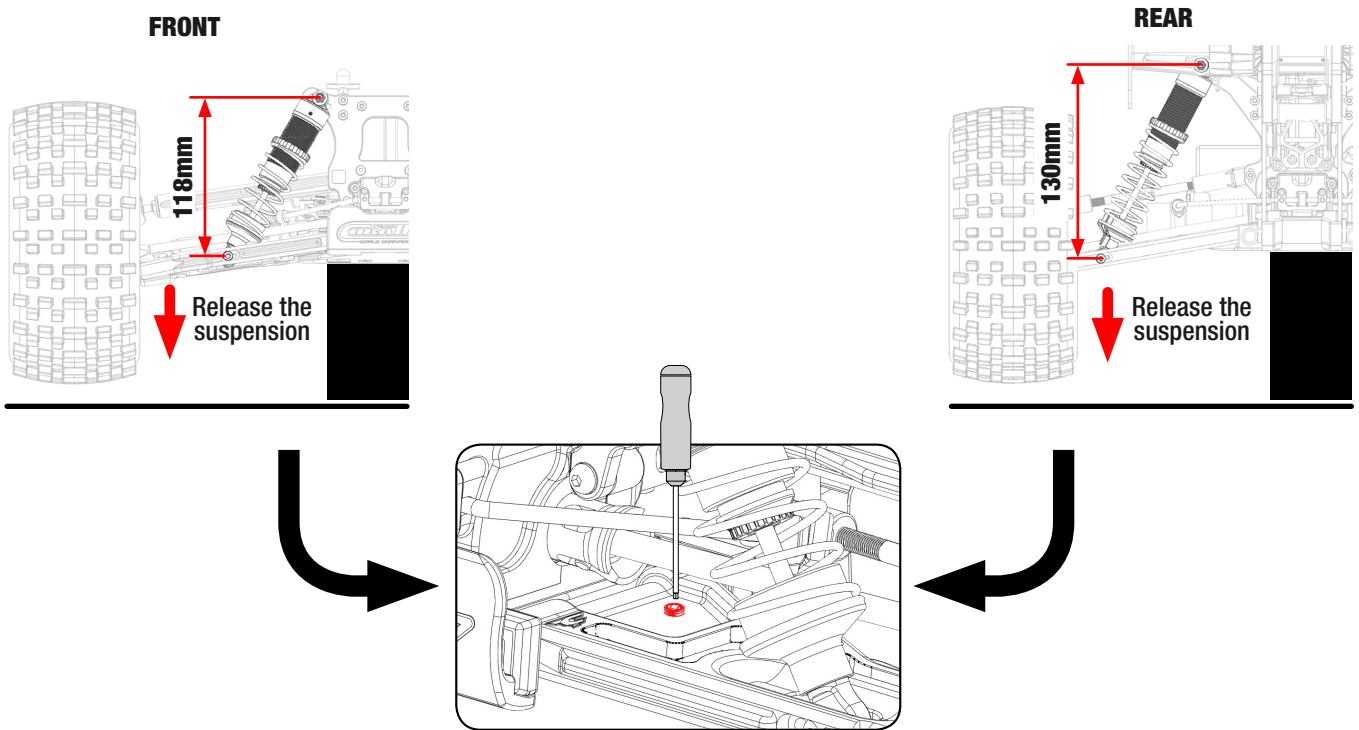

## RIDE HEIGHT

To achieve the correct ground clearance setting, follow the instructions below.

- Lift the car by  $\pm 30\text{cm}$  and drop the car on the floor.
- The front and rear suspension arms should be  $\pm$  parallel to the ground. (Neutral setup)
- Adjust the tension of the shock absorber spring according to the type of terrain.

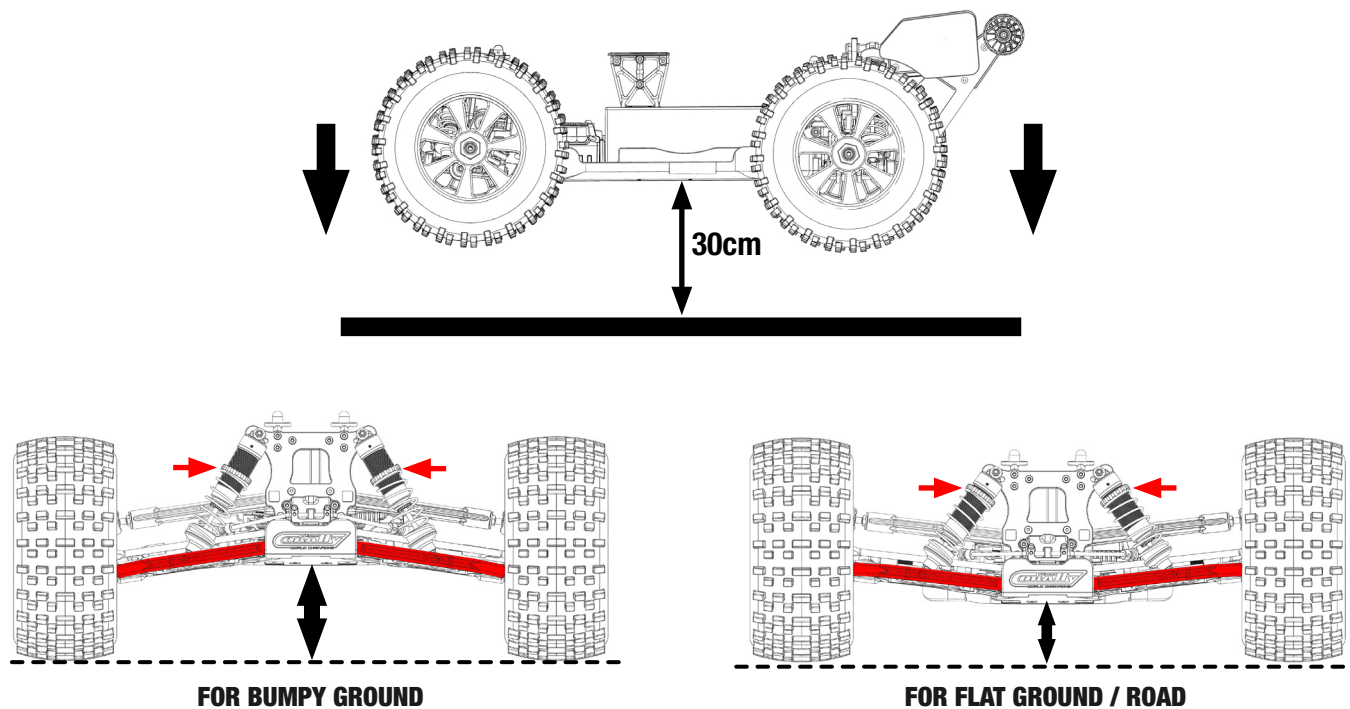

## SHOCK ABSORBER MAINTENANCE

It may be necessary to replace the silicone oil in the shock absorbers every 40 runs. It depends on how you drive and the type of terrain you drive on.

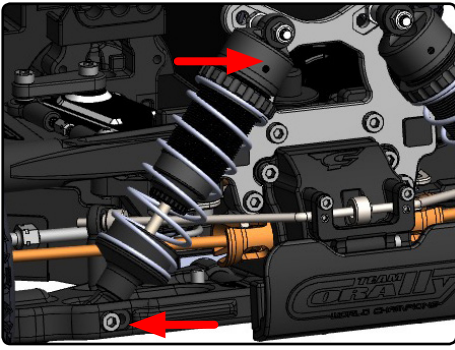

Remove the shock absorbers from the car. (4x)

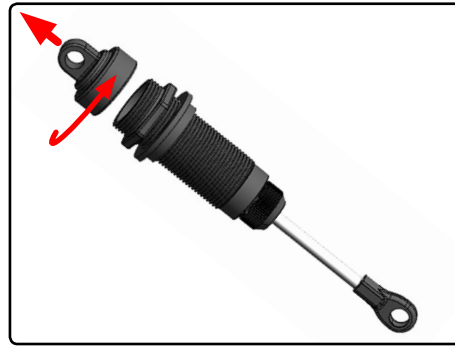

Remove the shock cap.

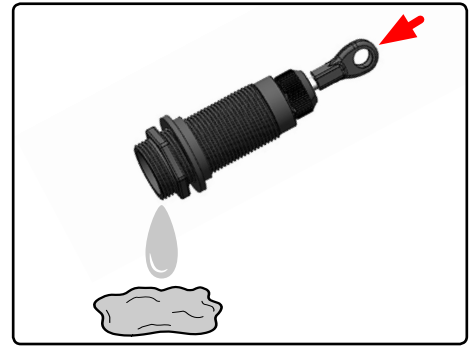

Drain the oil from the shock absorber.

### FILL THE SHOCK ABSORBERS WITH NEW SILICONE OIL

ALWAYS USE SILICONE OIL, NEVER USE ANY OTHER TYPES OF OIL.

#### FILL

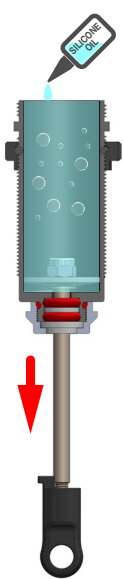

- Pull the Shock shaft down.
- Fill the shock body with silicone oil.
- **Front : 450cps**  
**Rear : 400cps**

#### MOVE UP

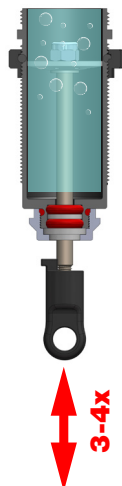

- Move the piston up&down (3-4x) to release the air bubbles in the silicone oil.

#### WAIT

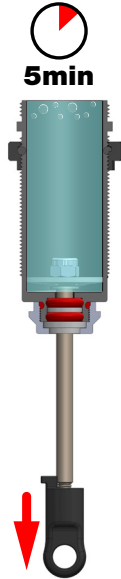

- Pull the Shock shaft down.
- Install the shock absorber vertically and let it sit for a few minutes until the bubbles rise to the surface.

#### TIGHTEN 50%

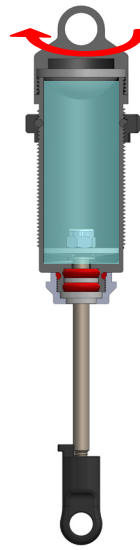

- Install the silicone membrane in the shock cap.
- Tighten slightly the shock cap on the shock body.
- A little oil will flow out of the shock absorber.

#### MOVE UP

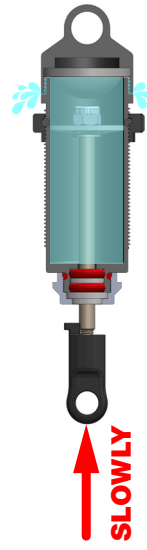

- Gently move the piston in upper position.
- The excess will flow out of the shock absorber.

#### TIGHTEN FULLY

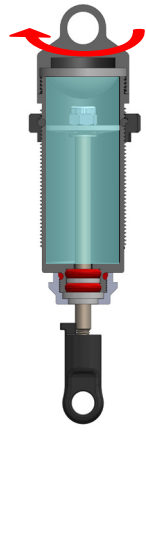

- Allow the piston in the upper position.
- Tighten the cap fully but not too much otherwise the membrane will be deformed.

	FRONT		REAR		SHOCK PISTON
	SILICONE OIL	SPRING TENSION	SILICONE OIL	SPRING TENSION	
TRACK USE	450CPS	4mm	400CPS	0mm	6 Holes Ø1.3mm
OFF-ROAD	600CPS	4mm	500CPS	0mm	6 Holes Ø1.3mm
BASHING	650CPS	4mm	550CPS	0mm	6 Holes Ø1.3mm

[www.corally.com/Chemicals/Silicone-Oils/](http://www.corally.com/Chemicals/Silicone-Oils/)

#### SPRING TENSION

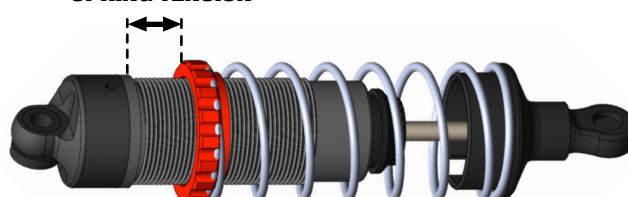

# SHOCK ABSORBER - EXPLODED VIEW

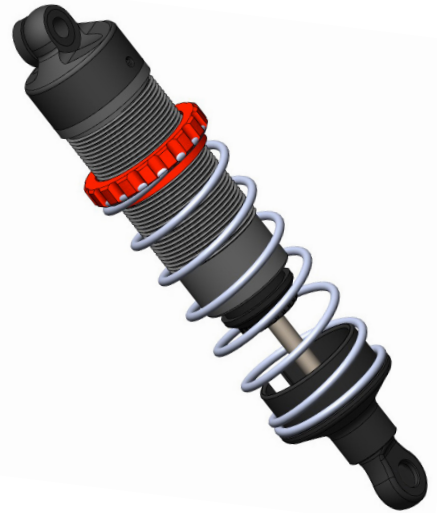

Do not overtighten the Shock Cap to prevent deformation of the silicone Shock Bladder.

### C-00180-080 Shock Piston

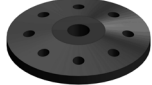

#### Set content

- Shock Piston - 4x1.6
- Shock Piston - 4x1.8
- Shock Piston - 5x1.4
- Shock Piston - 5x1.5
- Shock Piston - 5x1.6
- Shock Piston - 6x1.4
- Shock Piston - 6x1.3
- Shock Piston - 8x1.2
- Shock Piston - 8x1.3

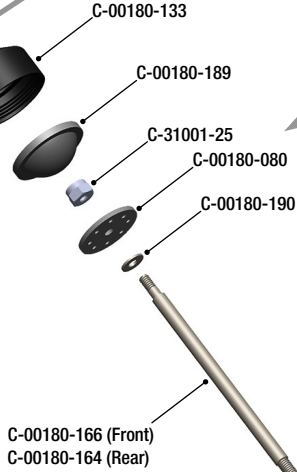

C-00180-166 (Front)  
C-00180-164 (Rear)

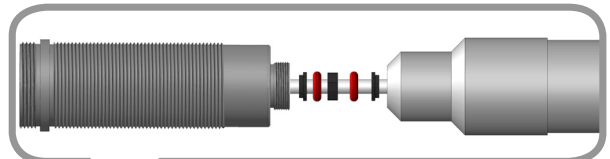

Place all small parts on a screwdriver (Ø3mm) and push them into the shock body. All parts will be properly aligned.

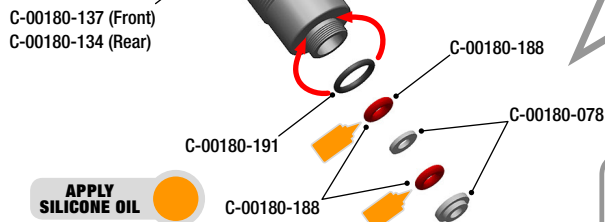

APPLY SILICONE OIL

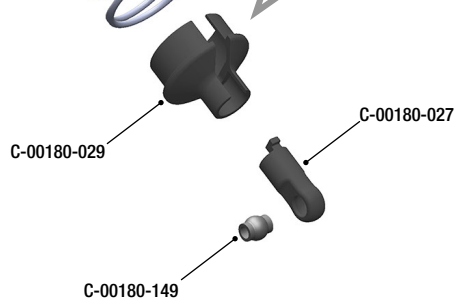
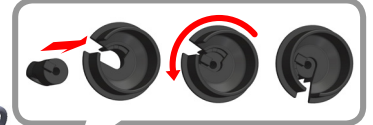
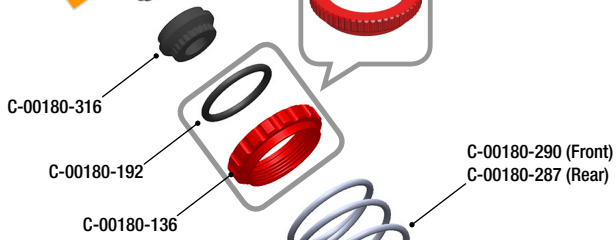

## DIFFERENTIAL MAINTENANCE

It may be necessary to replace the silicone oil every 50 runs.  
It depends on how you drive and the type of terrain you drive on.

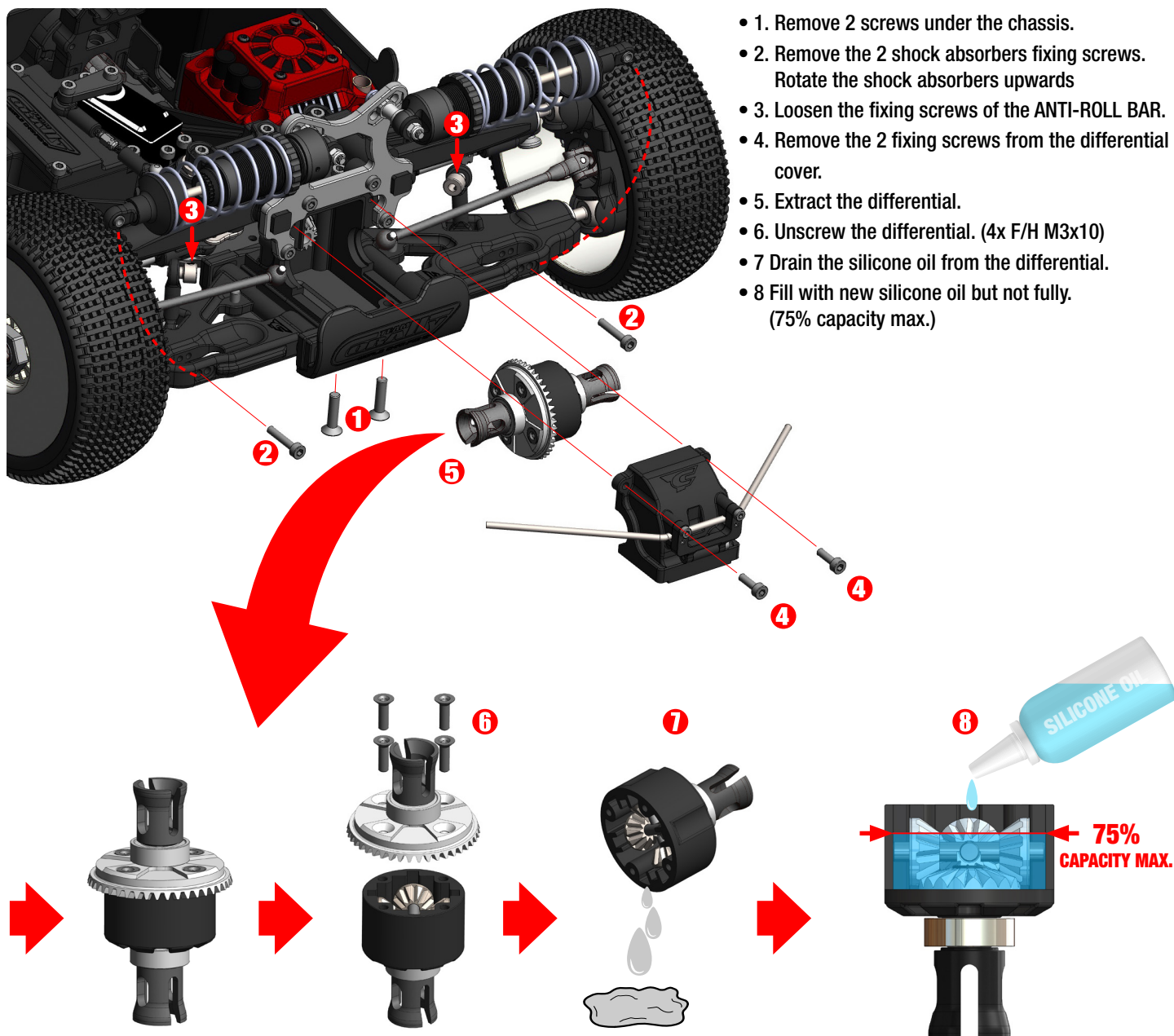

*Perform the same maintenance operations for the centre and rear differentials.*



Use the correct grade of silicone oil according to the operation.  
Use only Silicone Oil, never use any other types of oil.

	FRONT DIFF	CENTRE DIFF	REAR DIFF
TRACK USE	7500CPS	15.000CPS	5000CPS
OFF-ROAD	10.000CPS	30.000CPS	7500CPS
BASHING	20.000CPS	50>100.000CPS	10.000CPS

[www.corally.com/Chemicals/Silicone-Oils/](http://www.corally.com/Chemicals/Silicone-Oils/)



## FRONT & REAR DIFFERENTIAL - EXPLODED VIEW

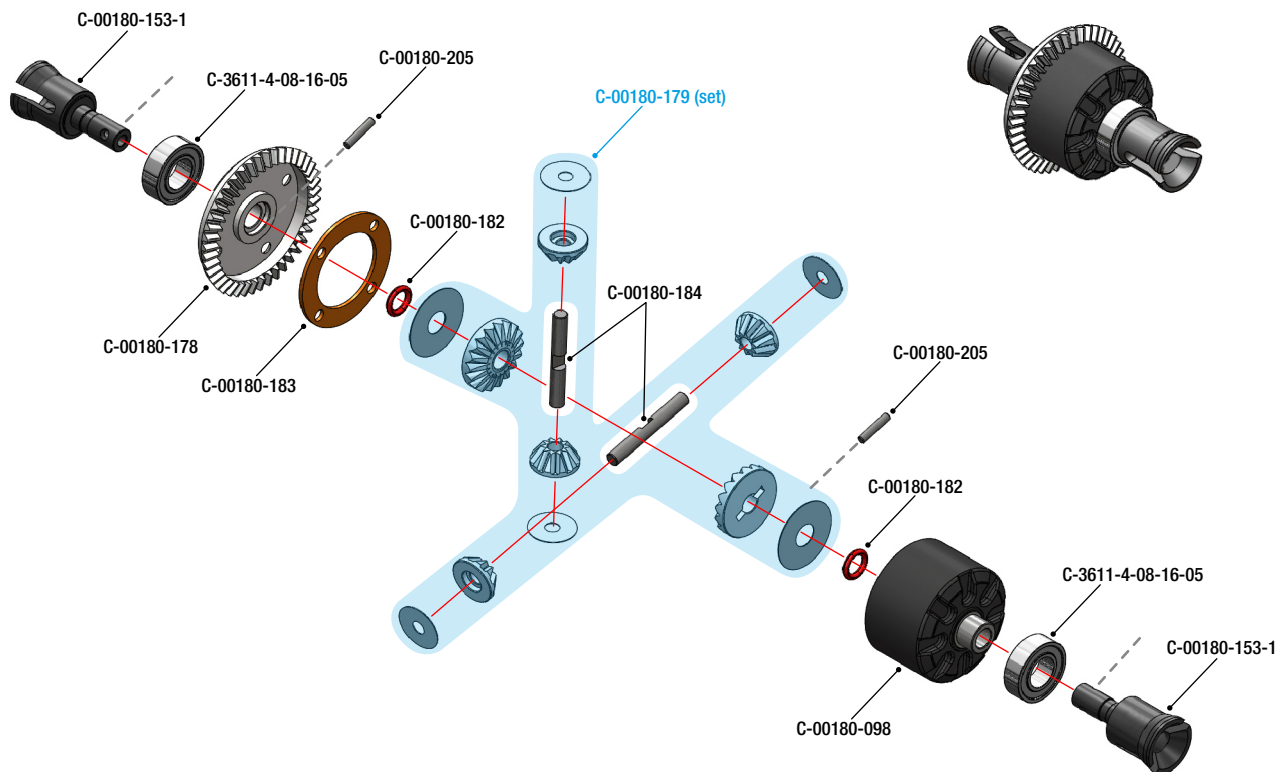

## CENTRE DIFFERENTIAL - EXPLODED VIEW

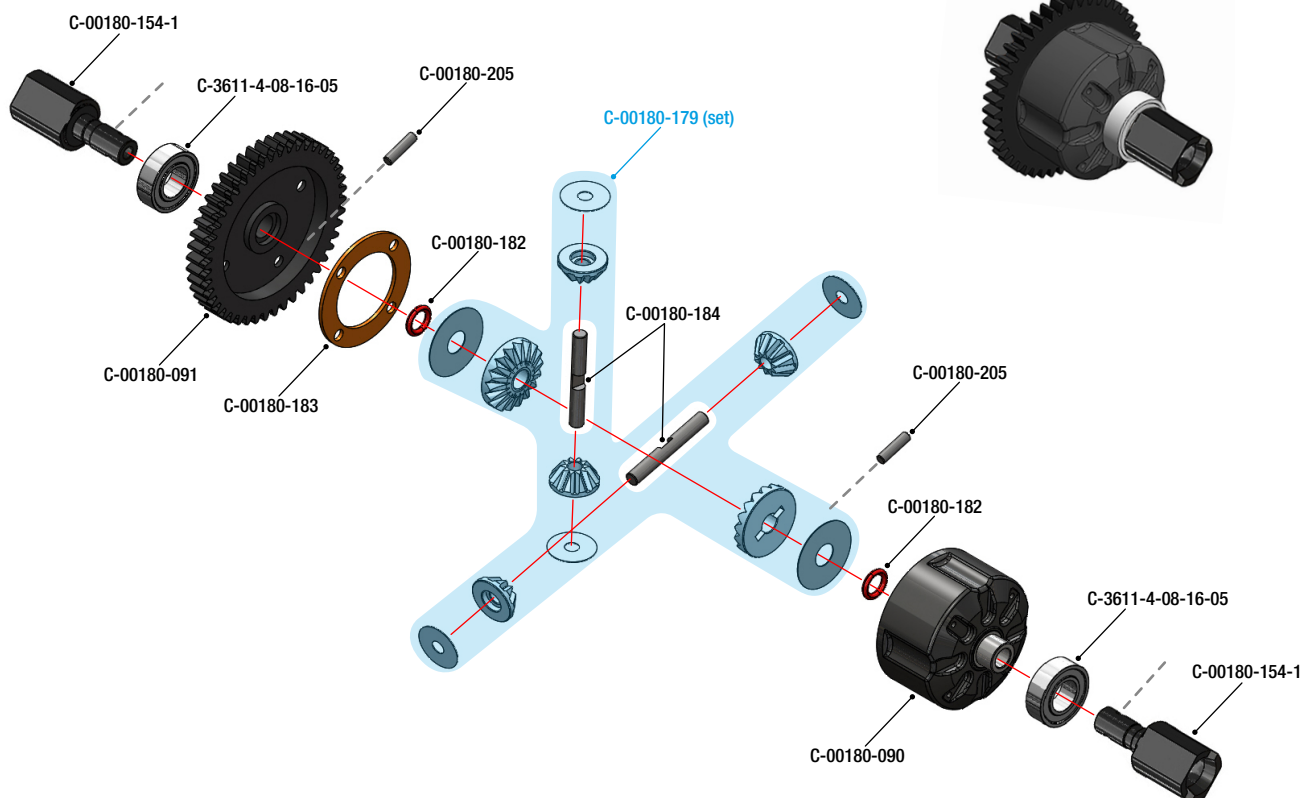

## GEAR RATIO

### MOTOR PINION MOD1.0

High-performance 13T tooth pinion gear, manufactured from special steel for toughness and durability with precise tolerances and assures unparalleled concentricity. Created on a special gear machine, all pinions feature ultra-precise tooth shaping and ultra-true running for vibration-free operation. Each pinion is marked with the tooth number for easy and quick identification.

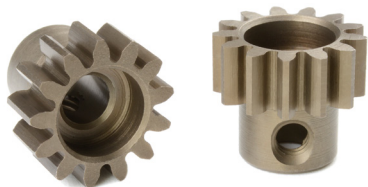

- Special hardened steel
- CNC cut teeth for perfect teeth shape and concentricity
- Module MOD1
- fits all cars with MOD1 gears (1/8 Scale)
- for 5.0mm motor shafts

[www.corally.com/Pinions-Gears/Pinions-MOD1/](http://www.corally.com/Pinions-Gears/Pinions-MOD1/)

Motor Pinion	11T C-72711	12T C-72712	13T C-72713	14T C-72714	15T C-72715	16T C-72716	17T C-72717	18T C-72718	19T C-72719	20T C-72720	21T C-72721	22T C-72722	23T C-72723
Spur Gear	46T	46T	46T	46T	46T	46T	46T	46T	46T	46T	46T	46T	46T
<b>3,08</b>	12,87	11,79	10,89	10,11	9,44	8,85	8,33	7,86	7,45	7,08	6,74	6,43	6,15
	Optional	Optional	Standard Fitted	Not Suitable	Not Suitable	Not Suitable	Not Suitable	Not Suitable	Not Suitable	Not Suitable	Not Suitable	Not Suitable	Not Suitable



## GEAR MESH ADJUSTMENT

If the gear mesh is not correct, you wear out the spur gear prematurely, the transmission will make noise, give unnecessary load on the motor (higher consumption, heating of the transmission).

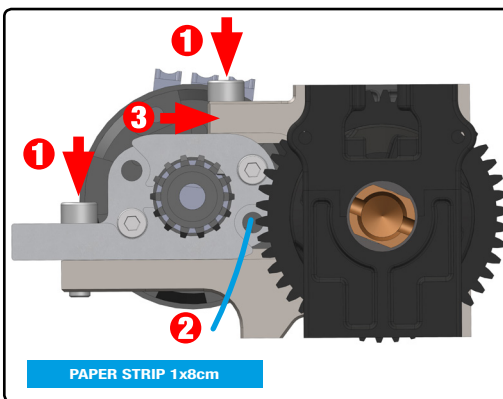
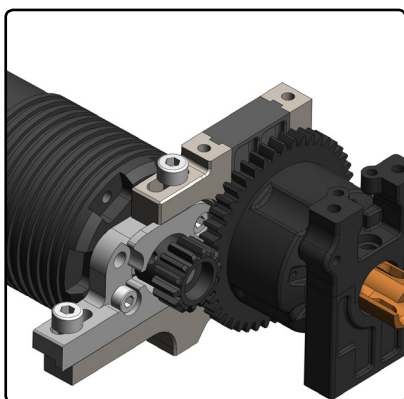

1. Loosen the screws.
2. Insert the paper strip.
3. Push the motor against the spur gear.

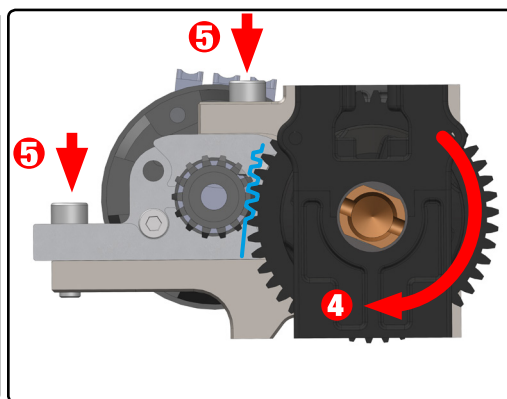

4. Turn the spur gear to run the paper through the teeth.  
Stop when the paper is in the middle.  
Make sure that the motor pinion is against the spur gear.
5. Tighten the fixing screws.

# FRONT DRIVE TRAIN - EXPLODED VIEW

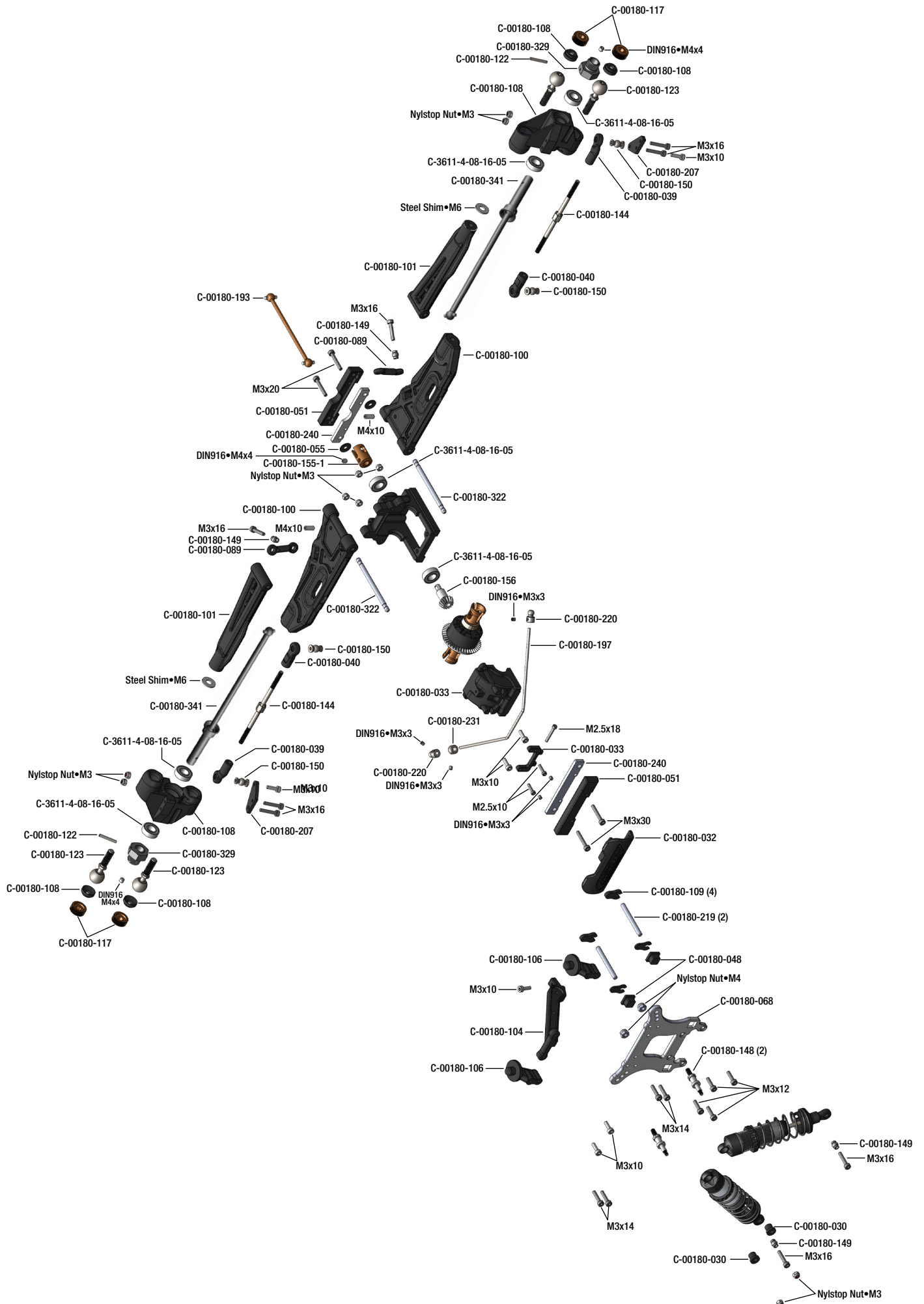

# REAR DRIVE TRAIN - EXPLODED VIEW

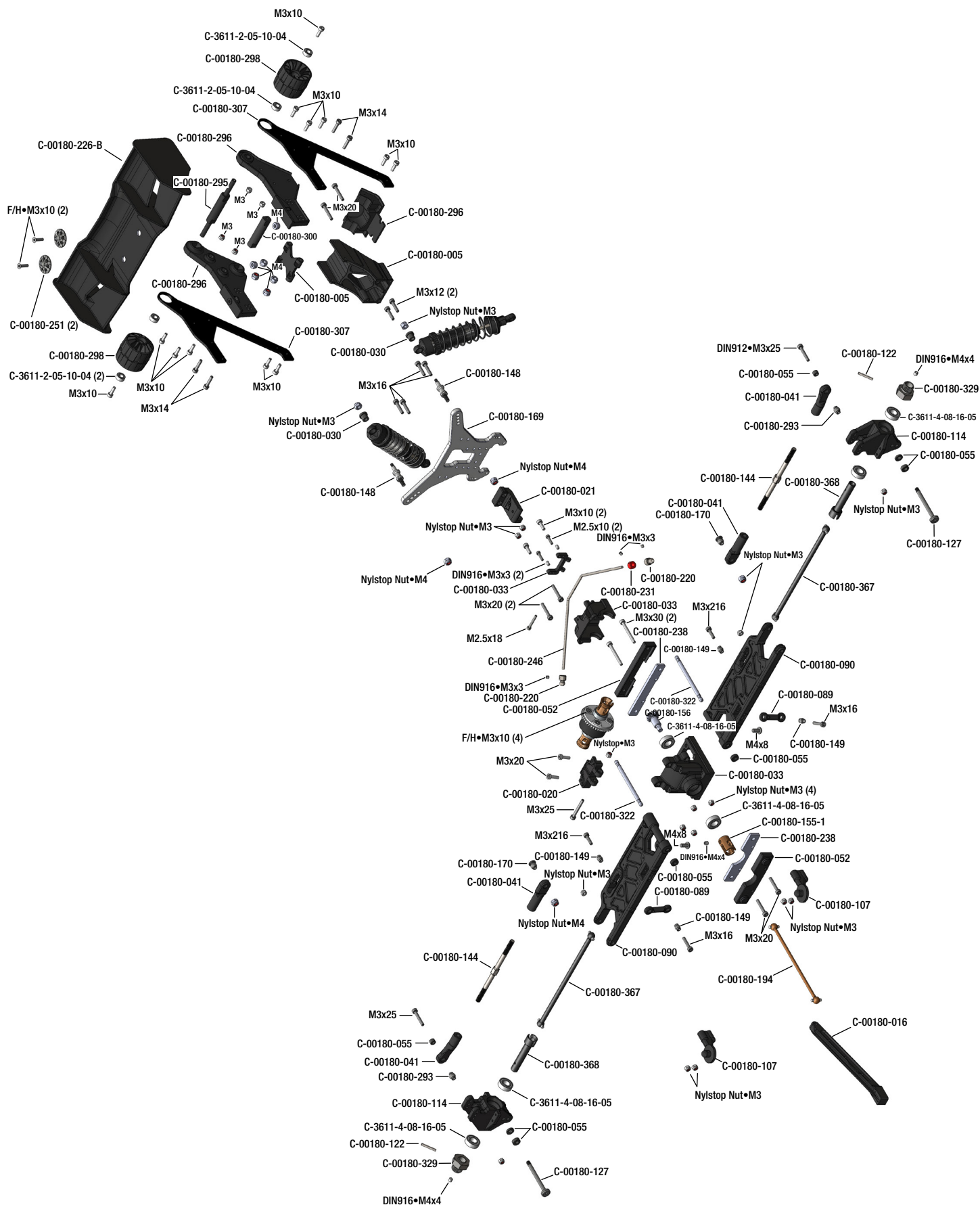



# CHASSIS - EXPLODED VIEW



**SEE SPARE PARTS AT**



**www.corally.com**



C-00180-004  
Battery - ESC Tray - Composite  
- 1 pc



C-00180-004-1  
Battery Strap - Hook & Loop  
- 2 pcs



C-00180-005  
Wing Mount - Adjustable -  
Composite - 1 Set



C-00180-013  
Servo Mount - Receiver Box -  
Composite - 1 Set



C-00180-015  
Centre Diff Plate - Spur Gear  
Cover - Composite - 1 pc



C-00180-016  
Chassis Brace - Rear - Com-  
posite - 1 pc



C-00180-017  
Arm Holder - Steering Deck -  
Composite - 1 pc



C-00180-018  
Centre Diff Bulkhead - Compos-  
ite - 1 Set



C-00180-020  
Gearbox Brace Mount A - Rear -  
Composite - 1 pc



C-00180-021  
Gearbox Brace Mount Stiffener  
- Composite - 1 pc



C-00180-023  
Motor Mount Centre Diff Insert -  
Composite - 1 pc



C-00180-027  
Body Post - Composite - 2 pcs

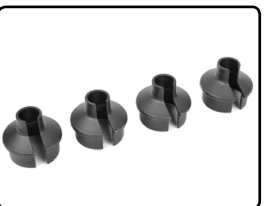

C-00180-029  
Shock Spring Cup - Composite  
- 4 pcs



C-00180-030  
Shock Bushing - Composite -  
4 pcs



C-00180-032  
Bumper - Front - Rear - Com-  
posite - 1 set

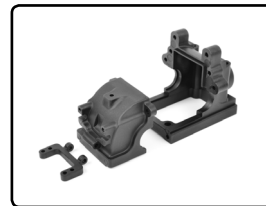

C-00180-033  
Bumper - Front - Rear - Com-  
posite - 1 set



C-00180-036  
Steering Bellcrank - Parts A-B-C  
- Composite - 1 set



C-00180-039  
Steering Ball Cups - Composite  
- 1 set



C-00180-041  
Rear Camber Ball Cups - Outer  
- Inner - 1 set



C-00180-044  
Ball Joint 6mm - Composite -  
2 pcs

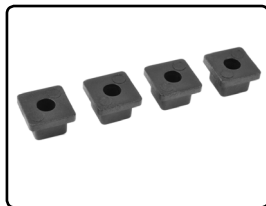

C-00180-048  
Bushings Set - 0 Deg -  
Composite - 1 Set

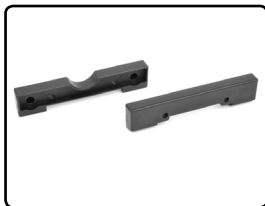

C-00180-051  
Suspension Arm Mount - Front -  
Composite - 1 Set

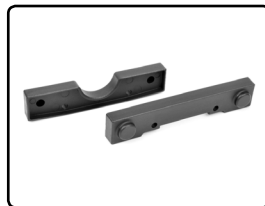

C-00180-052  
Suspension Arm Mount - Rear -  
Composite - 1 Set

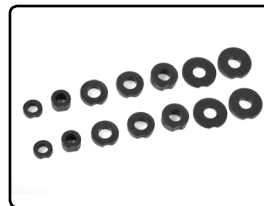

C-00180-055  
Suspension Arm Shim - Com-  
posite - 1 Set



C-00180-372  
Servo Arm - Steering - Alu -  
1 pc

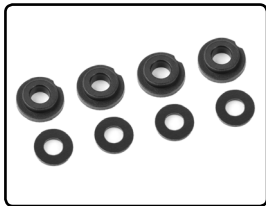

C-00180-078  
Shock Body Insert - Washer -  
Composite - 1 set

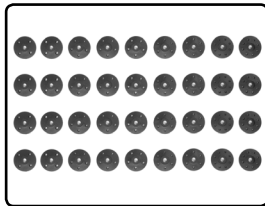

C-00180-080  
Shock Piston - Composite - 9  
versions - 4 pcs/type



C-00180-089  
Anti-Roll Bar Ball Cups - Com-  
posite - 4 pcs



C-00180-090  
Diff Case - Centre - Composite  
- 1 pc

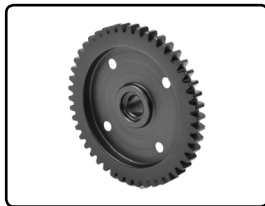

C-00180-091  
Spur Gear 46T - Steel - 1 pc



C-00180-098  
Diff Case - FR-RE - Composite  
- 1 pc



C-00180-099  
Suspension Arm Long - Lower -  
Rear - Composite - 1 pc



C-00180-100  
Suspension Arm Long - Lower -  
Front - Composite - 1 pc



C-00180-101  
Suspension Arm Long - Upper -  
Front - Composite - 1 pc

# SPARE PARTS



C-00180-102  
Chassis Brace - Front - Composite - 1 pc



C-00180-104  
Shock Tower Brace - Front - Composite - 1 pc

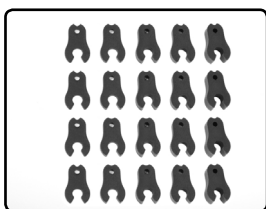

C-00180-109  
Caster Clips Set - 1 to 4.5mm - 1 Set



C-00180-106  
Body Post - Front - Composite - 2 pcs



C-00180-107  
Body Post - Rear - Composite - 2 pcs



C-00180-108  
Steering Block Wide - Pivot Ball Cup (2) - Front - Composite - 1 set



C-00180-114  
Rear Upright - MT - Composite - 1 pc



C-00180-117  
Pivot Ball Adjusting Nut - Aluminium - 4 pcs

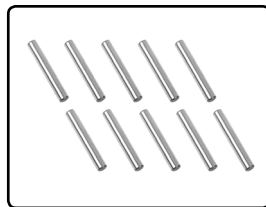

C-00180-122  
Pin 2.5x17mm - Steel - 10 pcs



C-00180-123  
Pivot Ball - Steel - 4 pcs



C-00180-127  
Hinge Pin - Outer - Steel - 2 pcs



C-00180-129  
Turnbuckle - M3 - 35mm - Steel - 2 pcs



C-00180-133  
Shock Cap - Aluminium - Hard Anodised - 2 pcs



C-00180-134  
Shock Body - Rear - Aluminium - Hard Anodised - 1 pc



C-00180-136  
Shock Collar - Aluminium - Hard Anodised - 2 pcs



C-00180-137  
Shock Body - Front - Aluminium - Hard Anodised - 1 pc



C-00180-143  
Turnbuckle - M5 - 92mm - Steel - 2 pcs



C-00180-144  
Turnbuckle - M4 - 92mm - Steel - 2 pcs



C-00180-145  
Servo Saver Shaft w/ Nut - Aluminium - 1 pc



C-00180-147  
Servo Saver Post - Steel - 2 pcs



C-00180-148  
Shock Screw - Steel - 4 pcs



C-00180-149  
Ball - 5.8mm - Steel - 4 pcs



C-00180-150  
Ball Shouldered - 6.8mm - Steel - 4 pcs



C-00180-153-1  
Diff. Outdrive Cup - Steel - 2 pcs



C-00180-154-1  
Centre Diff. Outdrive Cup - Steel - 2 pcs



C-00180-155-1  
Pinion Outdrive Cup - Steel - 2 pcs



C-00180-156  
Bevel Pinion 13T - Steel - 1 pc



C-00180-164  
Shock Shaft - 66mm - Rear - Steel - 2 pcs



C-00180-166  
Shock Shaft - 61mm - Front - Steel - 2 pcs



C-00180-168  
Shock Tower - 4mm - Aluminium - Front - 1 pc



C-00180-169  
Shock Tower - 5mm - Aluminium - Rear - 1 pc



C-00180-170  
Ball - 6.8mm - Steel - 2 pcs



C-00180-171  
Threaded Ball - 6mm - Steel - 2 pcs



C-00180-175  
Steering Rack - Aluminium 7075 - 1 pc



C-00180-176  
Motor Bulkhead - Aluminium - 1 pc



**SPARE PARTS**



C-00180-177  
Motor Mount - Aluminium - 1 pc



C-00180-178  
Diff. Bevel Gear 43T - Steel - 1 pc

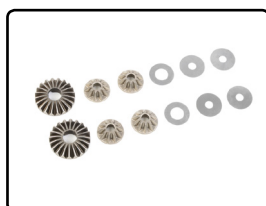

C-00180-179  
Planetary Diff. Gears - Steel - 1 Set

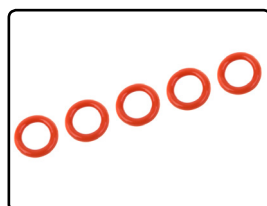

C-00180-182  
O-Ring - Silicone - 5x8mm - 5 pcs

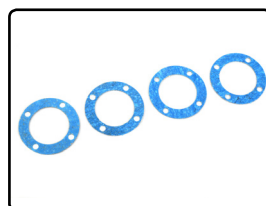

C-00180-183  
Diff. Gasket - 4 pcs



C-00180-184  
Gear Diff. Pin - Steel - 2 pcs



C-00180-188  
O-Ring - Silicone - 4x8mm - 5 pcs

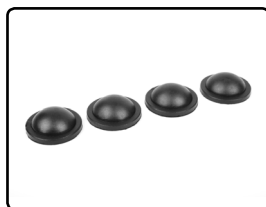

C-00180-189  
Shock Bladders - Silicone - 4 pcs

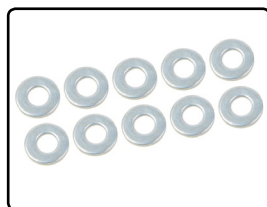

C-00180-190  
Shock Washer - 2.5x6x0.5mm - Steel - 10 pcs

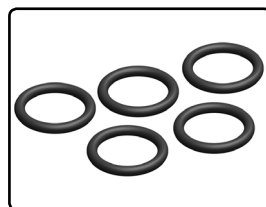

C-00180-191  
O-Ring - Silicone - 9x12mm - 5 pcs

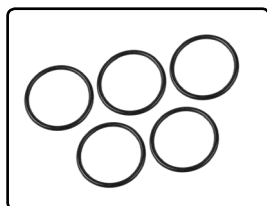

C-00180-192  
O-Ring - Silicone - 16.2x19.8mm - 5 pcs

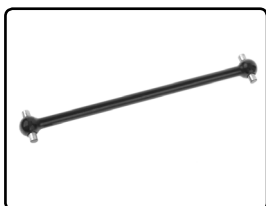

C-00180-193  
Drive Shaft - Centre - Front - Steel - 1 pc

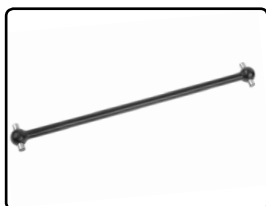

C-00180-194  
Drive Shaft - Centre - Rear - Steel - 1 pc

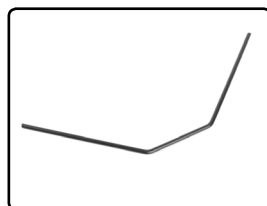

C-00180-197  
Anti-Roll Bar - 2.4mm - Front - 1 pc

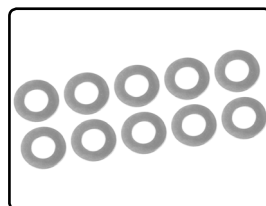

C-00180-204  
Shim Rings - 6x18x0.2mm - Steel - 10 pcs



C-00180-205  
Diff. Outdrive Pin - 2x10mm - Steel - 4 pcs



C-00180-206  
Steering Rack Bushing - Steel - 2 pcs



C-00180-207  
Steering Block Arms - Aluminium - 2 pcs

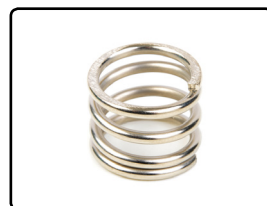

C-00180-216  
Servo Saver Spring - 1 pc

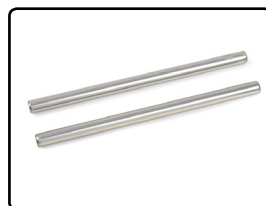

C-00180-219  
Suspension Arm Pivot Pin - Upper - Front - Steel - 2 pcs



C-00180-220  
Ball End 5.8mm - for Anti Roll Bar - Steel - 4 pcs



C-00180-226-B  
Wing - Composite - 1 pc

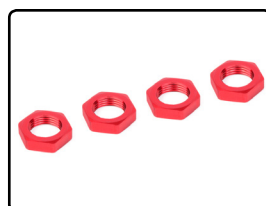

C-00180-230  
Wheel Nut - Aluminium - 4 pcs



C-00180-231  
Collar - for Anti-roll Bar - Aluminium - 1 pc

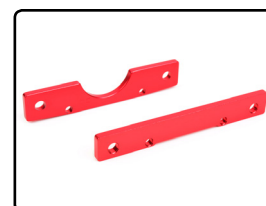

C-00180-238  
Suspension Arm Mount - Rear - Aluminium - 1 set

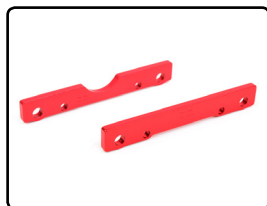

C-00180-240  
Suspension Arm Mount - Front - Aluminium - 1 Set



C-00180-242  
Side Guards - Left-Right - Composite - 1 Set



C-00180-246  
Anti-Roll Bar - 2.6mm - Rear - 1 pc

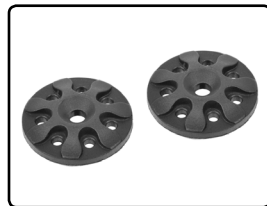

C-00180-251  
Wing Washer - Composite - 2 pcs

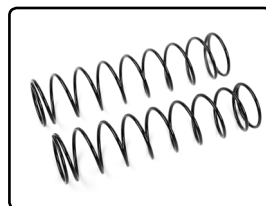

C-00180-287  
Shock Spring - Medium - Rear - 2 pcs

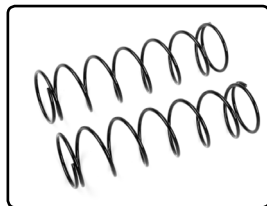

C-00180-290  
Shock Spring - Medium - Front - 2 pcs



C-00180-293  
Ball 6.8mm - Steel - 4 pcs



C-00180-295  
Wheelie Bar Wheel Axle - Steel - 1 pc



C-00180-296  
Wheelie Bar Mount - Left-Right - Composite - 1 set



C-00180-298  
Wheelie Bar Wheels - Composite - 2 pcs



# SPARE PARTS



C-00180-300  
Wheelie Bar Spacer - Aluminium  
- 1 pc

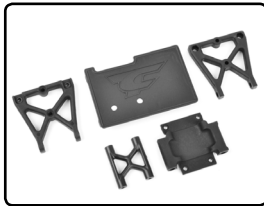

C-00180-301  
Centre Roll Cage Mount - Composite  
- 1 Set

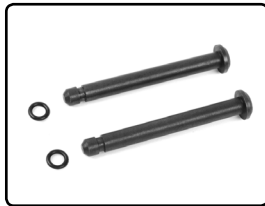

C-00180-305  
Centre Roll Cage Pin - Steel  
- 2 pcs



C-00180-307  
Wheelie Bar Plate - Aluminium  
- 1 pc



C-00180-316  
Shock Cap - Lower - Aluminium  
- 2 pcs

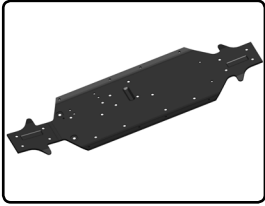

C-00180-321  
Chassis - Buggy XP RTR - Aluminium  
- 1 pc



C-00180-322  
Suspension Arm Pivot Pin - Lower Inner - Fr/Re - Steel  
- 2 pcs

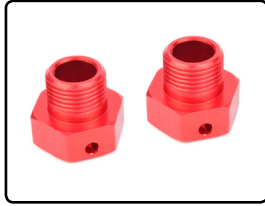

C-00180-329  
Wheel Hex Adapter - Wide RTR - Aluminium  
- 2 pcs



C-00180-341  
CVD Drive Shaft - Long - Front - Wide Blocks  
- 1 pc

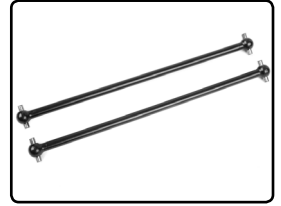

C-00180-367  
Dogbones - Long - Rear - Steel  
- 2 pcs



C-00180-368  
Drive Axle - Rear - Wide Hub - Steel  
- 2 pcs



C-00180-372  
Servo Arm - Steering - Aluminium  
- 1 pc



C-00180-378  
Off-Road 1/8 MT Tires - Gripper - Glued on Black Rims  
- 1 pair

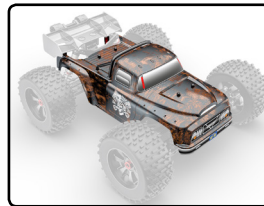

C-00180-381  
Polycarbonate Body - Dementor XP 6S - Painted - Cut  
- 1 pc

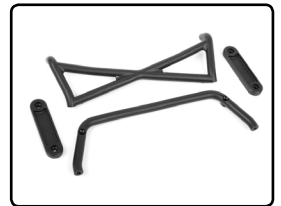

C-00180-383  
Roll Cage - Dementor  
- 1 Set

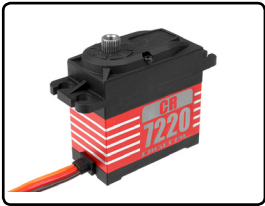

C-52021  
Digital Servo - CR-7220-MG - Low Voltage - Core Motor - Metal Gear  
- 20 Kg Torque



C-54011  
Speed Controller - TOROX 185 - Brushless  
- 2-6S



C-54055  
Electric Motor - Kuron 825 - 4-Pole - 2050 KV - Brushless - Sensorless



C-72713  
M1.0 Pinion - Hardened Steel - 13 Teeth - Shaft Dia. 5mm

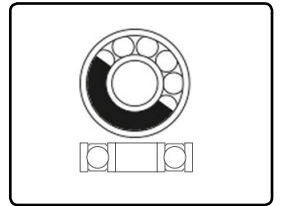

C-3611-3-05-10-04  
Ball Bearing - Abec 3 5x10x4mm  
- 2 pcs

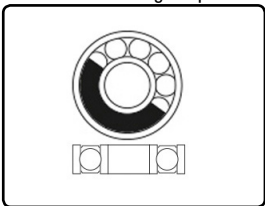

C-3611-4-06-10-03  
Ball Bearing - Abec 3 6x10x3mm  
- 2 pcs

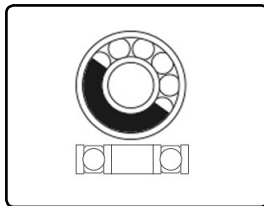

C-3611-4-08-16-05  
Ball Bearing - Abec 3 8x16x5mm  
- 2 pcs

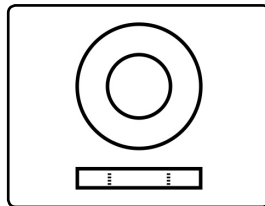

C-3201-40  
Steel Shim - M4  
- 10 pcs

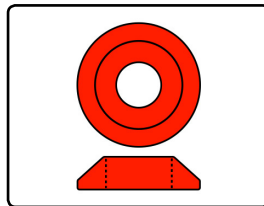

C-31205  
Aluminium Washer - for M3 Flat Head Screws - Red  
- 10 pcs

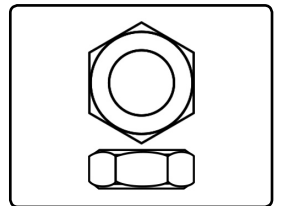

C-3104-40  
Steel Nut - Low Profile - M4  
- 10 pcs

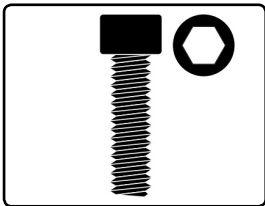

## SOCKET HEAD SCREWS - 10 PCS

- C-3001-25-10 M2.5x10
- C-3001-25-20 M2.5x20
- C-3001-30-06 M3x6
- C-3001-30-08 M3x8
- C-3001-30-10 M3x10
- C-3001-30-12 M3x12
- C-3001-30-14 M3x14
- C-3001-30-16 M3x16
- C-3001-30-20 M3x20
- C-3001-30-25 M3x25
- C-3001-30-30 M3x30
- C-3001-40-08 M4x8

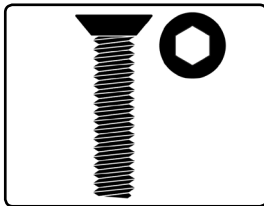

## FLAT HEAD SCREWS - 10 PCS

- C-3002-30-08 M3x8
- C-3002-30-10 M3x10
- C-3002-40-10 M4x10
- C-3002-40-12 M4x12
- C-3002-40-14 M4x14
- C-3002-40-16 M4x16
- C-3002-40-18 M4x18

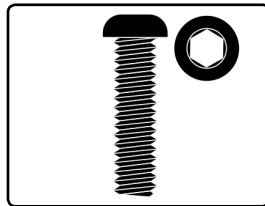

## BUTTON HEAD SCREWS - 10 PCS

- C-3003-30-06 M3x6
- C-3003-30-10 M3x10
- C-3003-30-12 M3x12
- C-3003-30-16 M3x16
- C-3003-40-12 M4x12

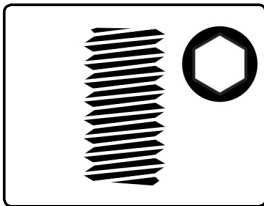

## SET SCREWS - 10 PCS

- C-3004-30-03 M3x3
- C-3004-30-05 M3x5
- C-3004-40-04 M4x4

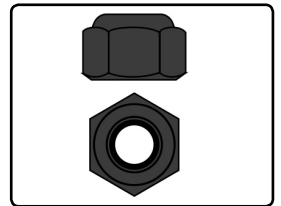

## NYLSTOP NUT - 10 PCS

- C-31001-25 M2.5
- C-31001-30 M3
- C-31001-40 M4

## OPTION PARTS

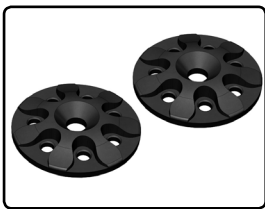

C-00180-157  
Wing Washer - Lightened -  
Aluminum - 2 pcs

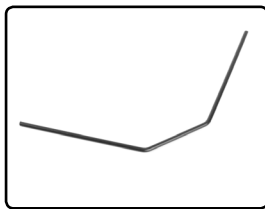

C-00180-195  
Anti-Roll Bar - 2.6mm - Front  
- 1 pc

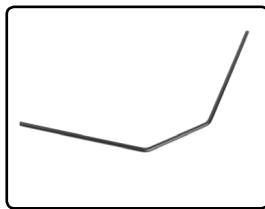

C-00180-196  
Anti-Roll Bar - 2.5mm - Front  
- 1 pc

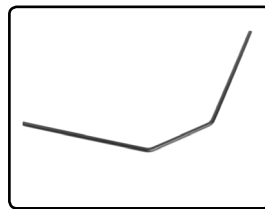

C-00180-198  
Anti-Roll Bar - 2.2mm - Front  
- 1 pc

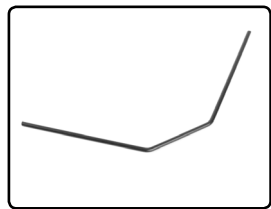

C-00180-199  
Anti-Roll Bar - 2.0mm - Front  
- 1 pc



C-00180-224  
Fan Holder - Composite - 1 set

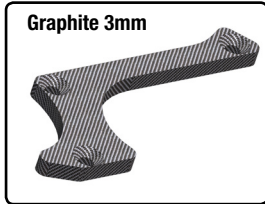

**Graphite 3mm**  
C-00180-232  
Susp. arm stiffener - A - Lower  
Front - Right - Graphite 3mm - 1 pc

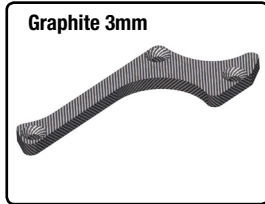

**Graphite 3mm**  
C-00180-233  
Susp. arm stiffener - A - Lower  
Front - Left - Graphite 3mm - 1 pc

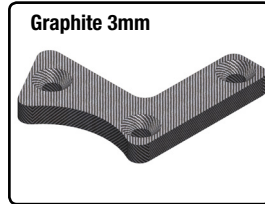

**Graphite 3mm**  
C-00180-234  
Susp. arm stiffener - B - Lower  
Front - Right - Graphite 3mm - 1 pc

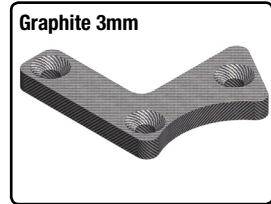

**Graphite 3mm**  
C-00180-235  
Susp. arm stiffener - B - Lower  
Front - Left - Graphite 3mm - 1 pc

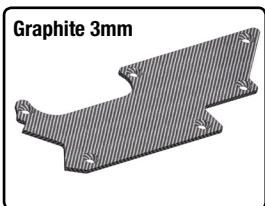

**Graphite 3mm**  
C-00180-236  
Suspension arm stiffener - Rear  
- Right - Graphite 3mm - 1 pc

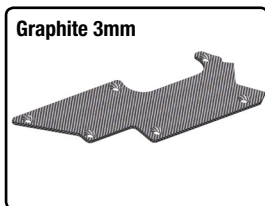

**Graphite 3mm**  
C-00180-237  
Suspension arm stiffener - Rear  
- Left - Graphite 3mm - 1 pc

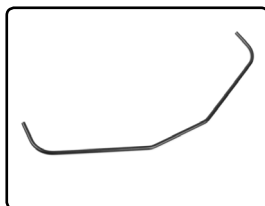

C-00180-247  
Anti-Roll Bar - Rear - 2.8mm  
- 1 pc

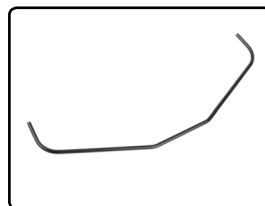

C-00180-248  
Anti-Roll Bar - Rear - 3.0mm  
- 1 pc

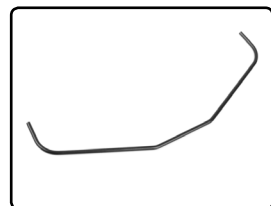

C-00180-249  
Anti-Roll Bar - Rear - 2.4mm  
- 1 pc

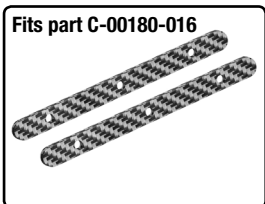

**Fits part C-00180-016**  
C-00180-253  
Chassis Brace Stiffener - Rear -  
Graphite 2.5mm - 2 pcs



**Fits part C-00180-104**  
C-00180-255  
Chassis Brace Stiffener - Front  
- Graphite 2.5mm - 2 pcs

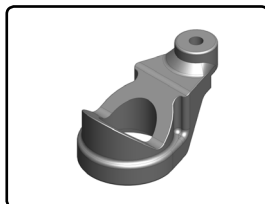

C-00180-266  
Servo Saver Steering Arm -  
Aluminium - 1 pc

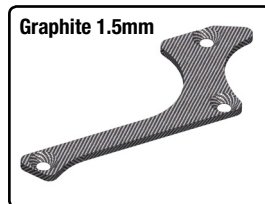

**Graphite 1.5mm**  
C-00180-272  
Susp. arm stiffener - A - Lower Front  
- Right - Graphite 1.5mm - 1 pc

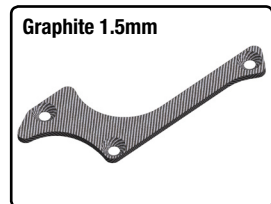

**Graphite 1.5mm**  
C-00180-273  
Suspension arm stiffener - A - Lower  
Front - Left - Graphite 1.5mm - 1 pc

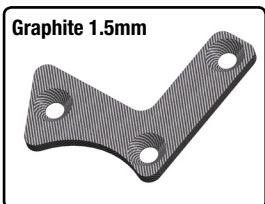

**Graphite 1.5mm**  
C-00180-274  
Susp. arm stiffener - B - Lower Front  
- Right - Graphite 1.5mm - 1 pc



**Graphite 1.5mm**  
C-00180-275  
Susp. arm stiffener - B - Lower Front  
- Left - Graphite 1.5mm - 1 pc

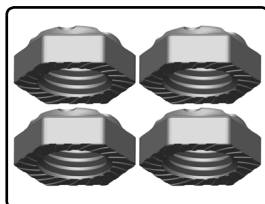

C-00180-284  
Wheel Nut - Closed - Aluminium  
- 4 pcs

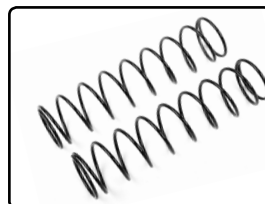

C-00180-286  
Shock Spring - Soft - Rear  
- 2 pcs

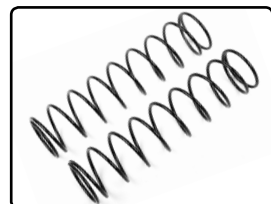

C-00180-288  
Shock Spring - Hard - Rear  
- 2 pcs

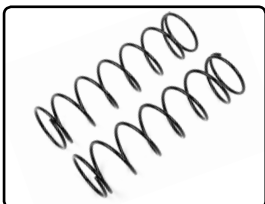

C-00180-289  
Shock Spring - Soft - Front  
- 2 pcs



C-00180-291  
Shock Spring - Hard - Front  
- 2 pcs



C-00180-308  
Wheelie Bar Plate - Graphite  
- 1 pc

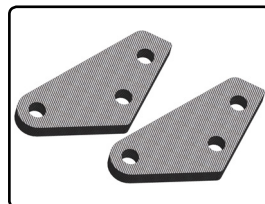

C-00180-315  
Steering Block Arms - Graphite  
2.5mm - 2 pcs

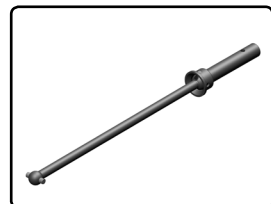

C-00180-346  
CVD Drive Shaft - Long - Rear -  
Wide Hub - 1 pc

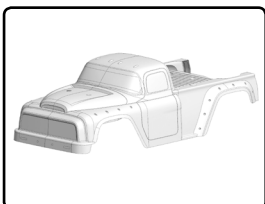

C-00180-382  
Polycarbonate Body - Dementor  
XP 6S - Clear - Cut - 1 pc



C-72714  
M1.0 Pinion - Hardened Steel -  
14 Teeth - Shaft Dia. 5mm

**DECLARATION OF CONFORMITY**  
**EU-Konformitätserklärung/ Déclaration de Conformité UE**

(in accordance with ISO/IEC 17050-1) / (in Übereinstimmung mit ISO/IEC 17050-1) /  
 (Conformément à la norme ISO/IEC 17050-1)

Description : **1/8 DEMENTOR MONSTER TRUCK 4WD - RTR**  
 Item Number: **C-00165**

This declaration is issued under the sole responsibility of the manufacturer.  
 Die alleinige Verantwortung für die Ausstellung dieser Erklärung trägt der Hersteller.  
 La présente déclaration est établie sous la seule responsabilité du fabricant.

Product(s)/Produkt(e)/ Produit(s) : **1/8 DEMENTOR MONSTER TRUCK 4WD - RTR**

The object of declaration described above is in conformity with the relevant Union harmonization Legislation, specifically the requirements of the specifications listed below, following the provisions of the European RED Directive 2014/53/EU:  
 Der Gegenstand dieser Erklärung ist konform mit den Harmonisierungsrechtsvorschriften der Europäischen Union, insbesondere mit den unten aufgeführten Bestimmungen, und folgt der europäischen RED Direktive 2014/53/EU:  
 L'objet de la déclaration décrit ci-dessus est conforme à la législation pertinente en matière d'harmonisation de l'Union européenne, en particulier les exigences des spécifications énumérées ci-dessous, conformément aux dispositions des directives européennes RED 2014/53/EU:

EN 300 440 V2.1.1:2017	EN 301 489-3 V1.6.1:2013
EN 301 489-1 V2.1.1:2017	EN 60950-1:2006+A11:2009+A1:2010+A12:2011+A2:2013
EN 62479:2010	EN 55024:2010+A1:2015
EN 55032:2015	EN 61000-3-3:2013
EN 61000-3-2:2014	

JSP GROUP INTL • Geelseweg, 80 • 2250 Olen • Belgium

Signed for and on behalf of/ Unterzeichnet für und im Namen von/ Signé pour et au nom de :

Place/Ort/Lieu and Date/Datum/Data : **Olen, Belgium, 25 September 2019**

Name/Nom: **Stefan Engelen**  
 Title/Titel/Titre : **Ceo**

Signature/Unterschrift :



**FEDERAL COMMUNICATIONS COMMISSION**

EQUIPMENT AUTHORIZATION is hereby issued to the named GRANTEE JSP GROUP INTL BVBA / CORALLY, and is VALID ONLY for the equipment identified hereon for use under the Commission's Rules and Regulations listed below.

FCC IDENTIFIER :	2ASZJ-VP010005
Name of Grantee :	JSP GROUP INTL BVBA / CORALLY
Equipment Class :	Part 15 Low Power Communication Device Transmitter
Notes :	VARIOPROP S2R
FCC Rules :	15C
Frequency Range (MHZ) :	2410.0 - 2480.0



[WWW.CORALLY.COM](http://WWW.CORALLY.COM)

Team Corally is a registered trademark licensed to  
JSP Group Intl bvba • Geelseweg 80 • B-2250 OLEN • Belgium  
Tel: +32 14 25 92 94 • [Info@corally.com](mailto:Info@corally.com)